

IM Relay

- Slim line 10x6mm, low profile 5.65mm and min. board-space 60mm²
- Switching current 2/5A, switching power 60W/62.5VA and switching voltage 220VDC/250VAC
- Low coil power consumption, 140mW standard, 100mW for high sensitive version, 50mW for ultra high sensitive version and 100mW for bistable version
- High dielectric and surge capability up to 2500Vrms between open contacts and 3000Vrms between coil and contacts
- High mechanical shock resistance up to 300g functional



IML



Typical applications

Telecommunication, access and transmission equipment, optical network terminals, modems, office and business equipment, consumer electronics, measurement and test equipment, industrial control, medical equipment, automotive applications

Approvals

UL 508 File No. E 111441
Technical data of approved types on request

| Contact Data | standard, C | D | P |
|-----------------------------|--------------------------------------|----------------------|--------------------------------|
| | standard and high dielectric version | high current version | high contact stability version |
| Contact arrangement | 2 form C, 2 CO | | |
| Max. switching voltage | 220VDC, 250VAC | 220VDC, 250VAC | 220VDC, 250VAC |
| Rated current | 2A | 5A | 2A |
| Limiting continuous current | 2A | 5A | 2A |
| Switching power | 60W, 62.5VA | | |
| Contact material | PdRu +Au covered | AgNi +Au covered | PdRu +Au covered |
| Contact style | twin contacts | | |
| Minimum switching voltage | 100µV | | |
| Initial contact resistance | <50mΩ at 10mA/20mV | | |
| Thermoelectric potential | <10µV | | |
| Operate time | typ. 1ms, max. 3ms | | |
| Release time | typ. 1ms, max. 3ms | | |
| without diode in parallel | typ. 3ms, max. 5ms | | |
| with diode in parallel | typ. 1ms, max. 5ms | | |
| Bounce time max. | typ. 1ms, max. 5ms | | |

Contact Data (continued)

| | |
|---|---|
| Electrical endurance at contact application 0 (≤30mV/≤10mA) | min. 2.5x10 ⁶ operations |
| cable load open end resistive, 125VDC / 0.24A - 30W | min. 2.0x10 ⁶ operations |
| resistive, 220 VDC / 0.27A - 60W | min. 5x10 ⁵ operations |
| resistive, 250VAC / 0.25A - 62.5VA | min. 1x10 ⁵ operations |
| resistive, 30VDC / 1A - 30W | min. 5x10 ⁵ operations |
| resistive, 30VDC / 2A - 60W | min. 1x10 ⁵ operations |
| Contact ratings, UL | 220VDC, 0.24A, 60W 125VDC, 0.24A, 30W 250VAC, 0.25A, 62.5VA 125VAC, 0.5A, 62.5VA 30VDC, 2A, 60W |
| Mechanical endurance | 10 ⁸ operations |

Coil Data

| | |
|--------------------|----------------------|
| Magnetic system | monostable, bistable |
| Coil voltage range | 1.5 to 24VDC |

Coil versions, standard version, monostable, 1 coil

| Coil code | Rated voltage VDC | Operate voltage VDC | Release voltage VDC | Coil resistance Ω±10% | Rated coil power mW |
|-----------|-------------------|---------------------|---------------------|-----------------------|---------------------|
| 00 | 1.5 | 1.13 | 0.15 | 16 | 140 |
| 08 | 2.4 | 1.80 | 0.24 | 41 | 140 |
| 01 | 3 | 2.25 | 0.30 | 64 | 140 |
| 02 | 4.5 | 3.38 | 0.45 | 145 | 140 |
| 03 | 5 | 3.75 | 0.50 | 178 | 140 |
| 04 | 6 | 4.50 | 0.60 | 257 | 140 |
| 05 | 9 | 6.75 | 0.90 | 579 | 140 |
| 06 | 12 | 9.00 | 1.20 | 1029 | 140 |
| 07 | 24 | 18.00 | 2.40 | 2880 | 200 |

All figures are given for coil without pre-energization, at ambient temperature +23°C

Max. DC load breaking capacity

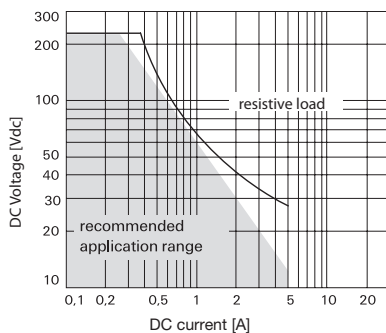

Coil operating range, standard version

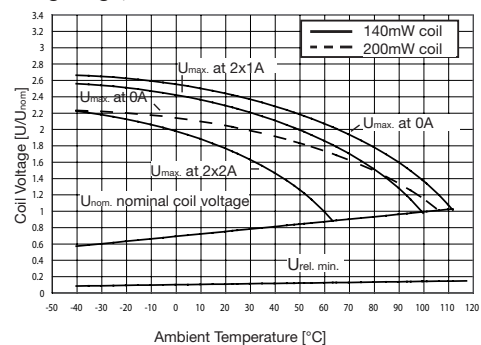

IM Relay (Continued)

Coil Data (continued)

Coil versions, sensitive version, monostable, 1 coil

| Coil code | Rated voltage VDC | Operate voltage VDC | Release voltage VDC | Coil resistance $\Omega \pm 10\%$ | Rated coil power mW |
|-----------|-------------------|---------------------|---------------------|-----------------------------------|---------------------|
| 11 | 3 | 2.40 | 0.30 | 91 | 100 |
| 12 | 4.5 | 3.60 | 0.45 | 194 | 100 |
| 13 | 5 | 4.00 | 0.50 | 234 | 100 |
| 16 | 12 | 9.60 | 1.20 | 1315 | 110 |
| 17 | 24 | 19.20 | 2.40 | 4120 | 140 |

Coil versions, ultra high sensitive version, monostable, 1 coil

| Coil code | Rated voltage VDC | Operate voltage VDC | Release voltage VDC | Coil resistance $\Omega \pm 10\%$ | Rated coil power mW |
|-----------|-------------------|---------------------|---------------------|-----------------------------------|---------------------|
| 21 | 3 | 2.55 | 0.30 | 180 | 50 |
| 22 | 4.5 | 3.83 | 0.45 | 405 | 50 |
| 23 | 5 | 4.25 | 0.50 | 500 | 50 |
| 26 | 12 | 10.20 | 1.20 | 2880 | 50 |

All figures are given for coil without pre-energization, at ambient temperature +23°C

Coil operating range, sensitive and ultra high sensitive coil



Coil versions, standard, bistable 1 coil

| Coil code | Rated voltage VDC | Set voltage VDC | Reset voltage VDC | Coil resistance $\Omega \pm 10\%$ | Rated coil power mW |
|-----------|-------------------|-----------------|-------------------|-----------------------------------|---------------------|
| 40 | 1.5 | 1.13 | -1.13 | 23 | 100 |
| 48 | 2.4 | 1.80 | -1.80 | 58 | 100 |
| 41 | 3 | 2.25 | -2.25 | 90 | 100 |
| 42 | 4.5 | 3.38 | -3.38 | 203 | 100 |
| 43 | 5 | 3.75 | -3.75 | 250 | 100 |
| 44 | 6 | 4.50 | -4.50 | 360 | 100 |
| 45 | 9 | 6.75 | -6.75 | 810 | 100 |
| 46 | 12 | 9.00 | -9.00 | 1440 | 100 |
| 47 | 24 | 18.00 | -18.00 | 2880 | 200 |

All figures are given for coil without pre-energization, at ambient temperature +23°C

Coil operating range, bistable 1 coil



Insulation Data

| | standard | C | D,P |
|---------------------------------|---|-------------------------|--|
| | standard, sensitive, ultra high sensitive version | high dielectric version | high current, high contact stability version |
| Initial dielectric strength | | | |
| between open contacts | 1000V _{rms} | 1500V _{rms} | 750V _{rms} |
| between contact and coil | 1800V _{rms} | 1800V _{rms} | 1500V _{rms} |
| between adjacent contacts | 1000V _{rms} | 1800V _{rms} | 750V _{rms} |
| Initial surge withstand voltage | | | |
| between open contacts | 1500V | 2500V | 1000V |
| between contact and coil | 2500V | 2500V | 2000V |
| between adjacent contacts | 1500V | 2500V | 1000V |
| Initial insulation resistance | | | |
| between insulated elements | >10 ⁹ Ω | >10 ⁹ Ω | >10 ⁹ Ω |
| Capacitance | | | |
| between open contacts | | max. 1pF | |
| between contact and coil | | max. 2pF | |
| between adjacent contacts | | max. 2pF | |

RF Data

| | |
|---|-----------------|
| Isolation at 100MHz/900MHz | -37.0dB/-18.8dB |
| Insertion loss at 100MHz/900MHz | -0.03dB/-0.33dB |
| Voltage standing wave ratio (VSWR) at 100MHz/900MHz | 1.06/1.49 |

Other Data

Material compliance: EU RoHS/ELV, China RoHS, REACH, Halogen content refer to the Product Compliance Support Center at www.te.com/customer-support/rohssupportcenter

| | |
|--|---------------------------------------|
| Ambient temperature | -40°C to +85°C |
| Thermal resistance | <150K/W |
| Category of environmental protection | |
| IEC 61810 | RT V - hermetically sealed |
| Degree of protection, IEC 60529 | IP 67, immersion cleanable |
| Vibration resistance (functional) | 20g, 10 to 500Hz |
| Shock resistance (functional), half sinus 11ms | 50g |
| Shock resistance (destructive), half sinus 0.5ms | 500g |
| Mounting position | any |
| Weight | max. 0.75g |
| Resistance to soldering heat THT | |
| IEC 60068-2-20 | 265°C/10s |
| Resistance to soldering heat SMT | |
| IEC 60068-2-58 | 265°C/10s |
| Moisture sensitive level, JEDEC J-Std-020D | MSL3 |
| Ultrasonic cleaning | not recommended |
| Packaging/unit | |
| THT version | tube/50pcs., box/1000 pcs. |
| SMT version | reel/1000 pcs., box/1000 or 5000 pcs. |

Terminal assignment

TOP view on relay

Monostable version rest condition

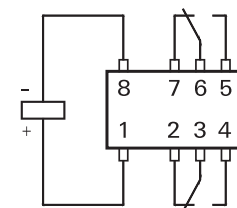

Bistable version, 1 coil reset condition

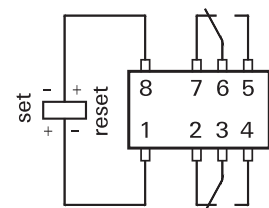

Contacts are shown in reset condition. Contact position might change during transportation and must be reset before use.

IM Relay (Continued)

Dimensions

THT version

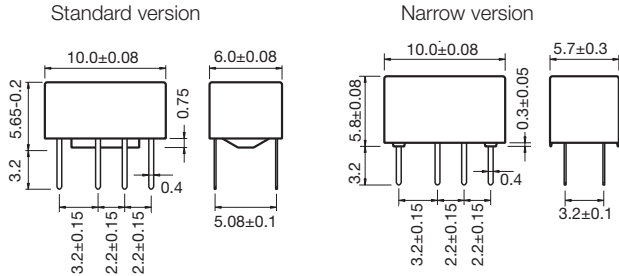

SMT version

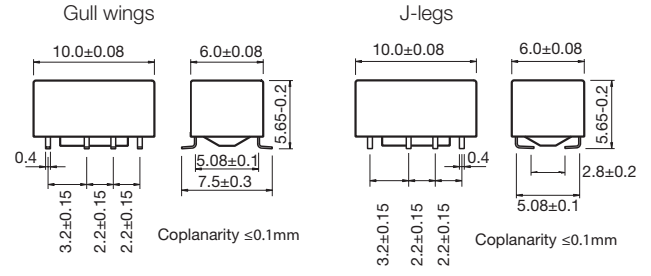

PCB layout

TOP view on component side of PCB

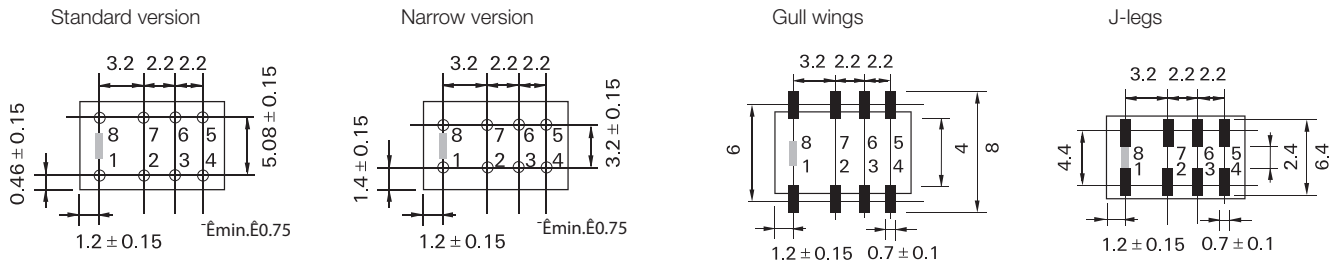

Processing

Recommended soldering conditions

Soldering conditions according IEC 60058-2-58 and IPC/JEDEC J-STD-020B

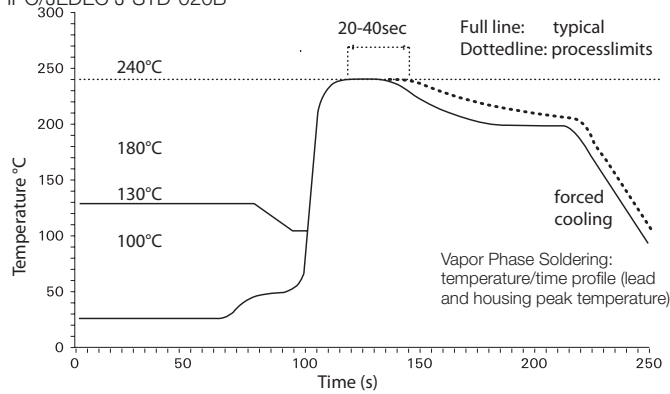

Recommended reflow soldering profile



Resistance to soldering heat - Reflow profile



IM Relay (Continued)

Packing

Tube for THT version
50 relays per tube, 1000 relays per box



Tape and reel for SMT version
1000 relays per reel, 1000 or 5000 relays per box

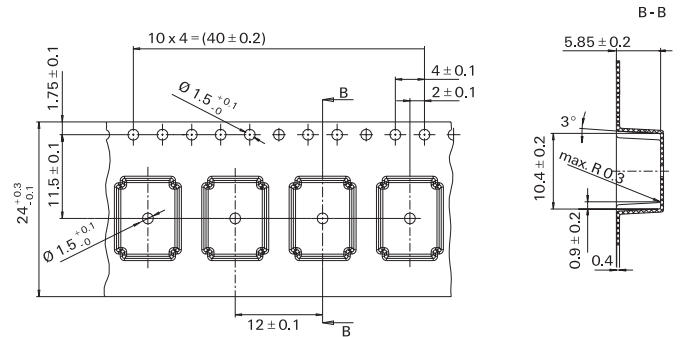

Reel dimensions



| | | | | | |
|-------------------------------|--|-----------|-----------|----------|----------|
| Product code structure | Typical product code | IM | 03 | G | R |
| Type | IM Signal Relays IM Series | | | | |
| Contact arrangement | Blank 2 form C, 2 CO | | | | |
| Coil | Coil code: please refer to coil versions table | | | | |
| Performance type | Blank Standard version C High dielectric version D High current version P High contact stability version | | | | |
| Terminals | T THT - standard J SMT - J-leg N THT - narrow version G SMT - gull wing | | | | |
| Packing | S Tube R Reel | | | | |

IM Relay (Continued)

| Product code | Arrangement | Perf. type | Coil | Coil type | Coil | Terminals | Part number |
|--------------|-------------------------------|------------|--------|------------|----------------------------|---------------|-------------|
| IM00GR | 2 form C, 2 CO contacts | Standard | 1.5VDC | Monostable | Standard | SMT gull wing | 3-1462037-7 |
| IM00JR | | | | | | SMT J-leg | 3-1462037-9 |
| IM00NS | | | | | | THT narrow | 1-1462038-0 |
| IM01GR | | | 3VDC | | | SMT gull wing | 1462037-1 |
| IM01JR | | | | | | SMT J-leg | 4-1462037-0 |
| IM01NS | | | | | | THT narrow | 1-1462038-1 |
| IM01TS | | | | | | THT standard | 1462037-4 |
| IM02GR | | | 4.5VDC | | | SMT gull wing | 1462037-9 |
| IM02JR | | | | | | SMT J-leg | 1-1462037-1 |
| IM02NS | | | | | | THT narrow | 1-1462038-2 |
| IM03GR | | | 5VDC | | | SMT gull wing | 1-1462037-4 |
| IM03JR | | | | | | SMT J-leg | 1-1462037-6 |
| IM03NS | | | | | | THT narrow | 1-1462038-3 |
| IM03TS | | | | | | THT standard | 1-1462037-8 |
| IM04GR | | | 6VDC | | | SMT gull wing | 4-1462037-2 |
| IM04JR | | | | | | SMT J-leg | 4-1462037-4 |
| IM04NS | | | | | | THT narrow | 1-1462038-4 |
| IM05GR | | | 9VDC | | | SMT gull wing | 3-1462037-4 |
| IM05JR | | | | | | SMT J-leg | 4-1462037-5 |
| IM05NS | | | | | | THT narrow | 1-1462038-5 |
| IM05TS | | | | | | THT standard | 2-1462037-2 |
| IM06GR | | | 12VDC | | | SMT gull wing | 2-1462037-3 |
| IM06JR | | | | | | SMT J-leg | 4-1462037-6 |
| IM06NS | | | | | | THT narrow | 1-1462038-6 |
| IM07GR | | | 24VDC | | | SMT gull wing | 4-1462037-7 |
| IM07JR | | | | | | SMT J-leg | 4-1462037-8 |
| IM07NS | | | | | | THT narrow | 1-1462038-7 |
| IM08GR | | | 2.4VDC | | | SMT gull wing | 6-1462039-3 |
| IM11GR | | | 3VDC | | High sens. | | 9-1462038-5 |
| IM12GR | | | 4.5VDC | | | | |
| IM13GR | | | 5VDC | | | | 1462039-4 |
| IM16GR | | | 12VDC | | | | 1462039-5 |
| IM17GR | | | 24VDC | | | | 1462039-6 |
| IM17TS | | | | | | THT standard | 4-1462039-6 |
| IM21GR | | | 3VDC | | Ultra high sensitive | SMT gull wing | 2-1462039-6 |
| IM21TS | | | | | | THT standard | 1-1462039-5 |
| IM22GR | | | 4.5VDC | | | SMT gull wing | 2-1462039-7 |
| IM22TS | | | | | | THT standard | 2-1462039-8 |
| IM23GR | | | 5VDC | | | SMT gull wing | 2-1462039-9 |
| IM23TS | | | | | | THT standard | 3-1462039-0 |
| IM25GR | | | 9VDC | | | SMT gull wing | 3-1462039-5 |
| IM25TS | | | | | | THT standard | 3-1462039-6 |
| IM26GR | | | 12VDC | | | SMT gull wing | 3-1462039-1 |
| IM26TS | | | | | | THT standard | 3-1462039-2 |
| IM40GR | | | 1.5VDC | Bistable | Standard | SMT gull wing | 5-1462037-1 |
| IM40JR | | | | | | | |
| IM40NS | | | | | | THT narrow | 1-1462038-8 |
| IM40TS | | | | | | THT standard | 5-1462037-0 |
| IM41GR | | | 3VDC | | | SMT gull wing | 5-1462037-4 |
| IM41JR | | | | | | SMT J-leg | 5-1462037-5 |
| IM41NS | | | | | | THT narrow | 1-1462038-9 |
| IM41TS | | | | | | THT standard | 5-1462037-3 |
| IM42GR | | | 4.5VDC | | | SMT gull wing | 3-1462037-1 |
| IM42JR | | | | | | SMT J-leg | 5-1462037-7 |
| IM42NS | | | | | | THT narrow | 2-1462038-0 |
| IM42TS | | | | | | THT standard | 5-1462037-6 |
| IM43GR | | | 5VDC | | | SMT gull wing | 5-1462037-9 |
| IM43JR | | | | | | SMT J-leg | 6-1462037-0 |
| IM43NS | | | | | | THT narrow | 2-1462038-1 |
| IM43TS | | | | | | THT standard | 5-1462037-8 |
| IM44GR | | | 6VDC | | | SMT gull wing | 6-1462037-2 |
| IM44JR | | | | | | SMT J-leg | 6-1462037-3 |
| IM44NS | | | | | | THT narrow | 2-1462038-2 |
| IM44TS | | | | | | THT standard | 6-1462037-1 |
| IM45GR | | | 9VDC | | | SMT gull wing | 6-1462037-4 |
| IM45JR | | | | | | SMT J-leg | 6-1462037-5 |
| IM45NS | | | | | | THT narrow | 2-1462038-3 |
| IM46GR | | | 12VDC | | | SMT gull wing | 6-1462037-7 |
| IM46JR | | | | | | SMT J-leg | 6-1462037-8 |
| IM46NS | | | | | | THT narrow | 2-1462038-4 |
| IM46TS | | | | | | THT standard | 6-1462037-6 |
| IM47GR | | | 24VDC | | | SMT gull wing | 7-1462037-0 |
| IM47JR | | | | | | SMT J-leg | 7-1462037-1 |
| IM47NS | | | | | | THT narrow | 2-1462038-5 |
| IM47TS | | | | | | THT standard | 6-1462037-9 |
| IM48GR | | | 2.4VDC | | | SMT gull wing | 1462039-8 |

IM Relay (Continued)

| Product code | Arrangement | Perf. type | Coil | Coil type | Coil | Terminals | Part number | | | | | | | | | | | | | | | | | | | | | | | | | | |
|--------------|------------------------|-----------------|-----------|---------------|-------------|---------------|--------------|---------------|---------------|-------------|--------------|---------------|---------------|---------------|-------------|--------------|-------------|---------------|--------------|-------------|---------------|-----------|-----------|-------------|---------------|-------------|--------|-------------|----------|-------------|---------------|---------------|-------------|
| IM01CGR | 2 form C | High dielectric | 3VDC | Monostable | Standard | SMT gull wing | 1462038-4 | | | | | | | | | | | | | | | | | | | | | | | | | | |
| IM01CTS | 2 CO | | 4.5VDC | | | THT standard | 9-1462038-6 | | | | | | | | | | | | | | | | | | | | | | | | | | |
| IM02CGR | contacts | | | | | | 5VDC | SMT gull wing | 1462038-1 | | | | | | | | | | | | | | | | | | | | | | | | |
| IM03CGR | | | | | | | | | SMT gull wing | 1462038-2 | | | | | | | | | | | | | | | | | | | | | | | |
| IM03CJR | | | | | | | | | | SMT J-leg | 4-1462039-8 | | | | | | | | | | | | | | | | | | | | | | |
| IM03CTS | | | | | | | | | | | THT standard | 4-1462039-7 | | | | | | | | | | | | | | | | | | | | | |
| IM05CGR | | | | | | | | | | | | 9VDC | SMT gull wing | 1462038-3 | | | | | | | | | | | | | | | | | | | |
| IM06CGR | | | | | | | | | | | | | | SMT gull wing | 9-1462037-9 | | | | | | | | | | | | | | | | | | |
| IM06CJR | | | | | | | | | | | | | | | SMT J-leg | 3-1462039-4 | | | | | | | | | | | | | | | | | |
| IM06CTS | | | | | | | | | | | | | | | | THT standard | 4-1462037-9 | | | | | | | | | | | | | | | | |
| IM07CGR | | | | | | | | | | | | | | | | | 24VDC | SMT gull wing | 1462039-2 | | | | | | | | | | | | | | |
| IM07CTS | | | | | | | | | | | | | | | | | | | THT standard | 1462039-1 | | | | | | | | | | | | | |
| IM17CGR | | | | | | | | | | | | | | | | | | | | High sens. | SMT gull wing | 1462039-7 | | | | | | | | | | | |
| IM41CGR | | | | | | | | | | | | | | | | | | | | | | 3VDC | Bistable | Standard | 4-1462039-2 | | | | | | | | |
| IM42CGR | | | | | | | | | | | | | | | | | | | | | | | | | 4.5VDC | 4-1462039-1 | | | | | | | |
| IM43CGR | | | | | | | | | | | | | | | | | | | | | | | | | | | 5VDC | 9-1462038-7 | | | | | |
| IM02DGR | High current | | | | | | | | | | | | | | | | | | | | | | | | | | | | 4.5VDC | Monostable | Standard | 9-1462038-8 | |
| IM03DGR | | 9-1462038-9 | | | | | | | | | | | | | | | | | | | | | | | | | | | | | | | |
| IM03DJR | | | SMT J-leg | 3-1462039-3 | | | | | | | | | | | | | | | | | | | | | | | | | | | | | |
| IM05DGR | | | | SMT gull wing | 1-1462039-7 | | | | | | | | | | | | | | | | | | | | | | | | | | | | |
| IM06DGR | | | | | 12VDC | 1-1462039-8 | | | | | | | | | | | | | | | | | | | | | | | | | | | |
| IM06DJR | | | | | | SMT J-leg | 7-1462039-0 | | | | | | | | | | | | | | | | | | | | | | | | | | |
| IM06DTS | | | | | | | THT standard | 3-1462039-8 | | | | | | | | | | | | | | | | | | | | | | | | | |
| IM07DGR | | | | | | | | 24VDC | SMT gull wing | 3-1462039-7 | | | | | | | | | | | | | | | | | | | | | | | |
| IM07DJR | | | | | | | | | | SMT J-leg | 7-1462039-4 | | | | | | | | | | | | | | | | | | | | | | |
| IM07DTS | | | | | | | | | | | THT standard | 7-1462039-2 | | | | | | | | | | | | | | | | | | | | | |
| IM22DTS | | | | | | | | | | | | 4.5VDC | U.h.sens. | 7-1462039-6 | | | | | | | | | | | | | | | | | | | |
| IM41DGR | | | | | | | | | | | | | | 3VDC | Bistable | Standard | 6-1462039-8 | | | | | | | | | | | | | | | | |
| IM42DGR | | | | | | | | | | | | | | | | | 4.5VDC | 1-1462039-9 | | | | | | | | | | | | | | | |
| IM42DNS | | | | | | | | | | | | | | | | | | | THT narrow | 1-1462039-6 | | | | | | | | | | | | | |
| IM46DNS | | | | | | | | | | | | | | | | | | | | 12VDC | 1-1462039-2 | | | | | | | | | | | | |
| IM47DJR | | | | | | | | | | | | | | | | | | | | | | 24VDC | SMT J-leg | 7-1462039-5 | | | | | | | | | |
| IM48DGR | | | | | | | | | | | | | | | | | | | | | | | | 2.4VDC | SMT gull wing | 1462039-9 | | | | | | | |
| IM49DGR | | 2VDC | | | | | | | | | | | | | | | | | | | | | | | | 2-1462039-2 | | | | | | | |
| IM02PGR | High contact stability | | | | | | | | | | | | | | | | | | | | | | | | | | 4.5VDC | Monostable | Standard | 5-1462039-4 | | | |
| IM02PNS | | | | | | | | | | | | | | | | | | | | | | | | | | | | | | THT narrow | 5-1462039-8 | | |
| IM03PGR | | | | 5VDC | | | | | | | | | | | | | | | | | | | | | | | | | | | SMT gull wing | 5-1462039-5 | |
| IM03PJR | | | | | SMT J-leg | | | | | | | | | | | | | | | | | | | | | | | | | | | 6-1462039-6 | |
| IM03PNS | | | | | | THT narrow | | | | | | | | | | | | | | | | | | | | | | | | | | 5-1462039-9 | |
| IM06PGR | | | | | | | 12VDC | | | | | | | | | | | | | | | | | | | | | | | | | SMT gull wing | 5-1462039-6 |
| IM06PNS | | | | | | | | THT narrow | 6-1462039-0 | | | | | | | | | | | | | | | | | | | | | | | | |
| IM42PGR | | | | | | | | | 4.5VDC | Bistable | | | | | | | | | | | | | | | | | | | | | | | Standard |
| IM42PNS | | | | | | | | | | | THT narrow | | | | | | | | | | | | | | | | | | | | | | |
| IM43PGR | | | | | | | | | | | | SMT gull wing | 7-1462039-3 | | | | | | | | | | | | | | | | | | | | |
| IM46PNS | | | | | | | | | | | | | 12VDC | THT narrow | 6-1462039-1 | | | | | | | | | | | | | | | | | | |